

FLUKE®

27
Multimeter

Users Manual

Test Equipment Depot
99 Washington Street
Melrose, MA 02176-6024

www.testequipmentdepot.com
800-517-8431
781-665-0780 FAX

For IEC 61010 CAT III Meters Only

LIMITED WARRANTY & LIMITATION OF LIABILITY

Each Fluke 20, 70, 80, 170 and 180 Series DMM will be free from defects in material and workmanship for its lifetime. As used herein, "lifetime" is defined as seven years after Fluke discontinues manufacturing the product, but the warranty period shall be at least ten years from the date of purchase. This warranty does not cover fuses, disposable batteries, damage from neglect, misuse, contamination, alteration, accident or abnormal conditions of operation or handling, including failures caused by use outside of the product's specifications, or normal wear and tear of mechanical components. This warranty covers the original purchaser only and is not transferable.

For ten years from the date of purchase, this warranty also covers the LCD. Thereafter, for the lifetime of the DMM, Fluke will replace the LCD for a fee based on then current component acquisition costs.

To establish original ownership and prove date of purchase, please complete and return the registration card accompanying the product, or register your product on <http://www.fluke.com>. Fluke will, at its option, repair at no charge, replace or refund the purchase price of a defective product purchased through a Fluke authorized sales outlet and at the applicable international price. Fluke reserves the right to charge for importation costs of repair/replacement parts if the product purchased in one country is sent for repair elsewhere.

If the product is defective, contact your nearest Fluke authorized service center to obtain return authorization information, then send the product to that service center, with a description of the difficulty, postage and insurance prepaid (FOB Destination). Fluke assumes no risk for damage in transit. Fluke will pay return transportation for product repaired or replaced in-warranty. Before making any non-warranty repair, Fluke will estimate cost and obtain authorization, then invoice you for repair and return transportation.

THIS WARRANTY IS YOUR ONLY REMEDY. NO OTHER WARRANTIES, SUCH AS FITNESS FOR A PARTICULAR PURPOSE, ARE EXPRESSED OR IMPLIED. FLUKE SHALL NOT BE LIABLE FOR ANY SPECIAL, INDIRECT, INCIDENTAL OR CONSEQUENTIAL DAMAGES OR LOSSES, INCLUDING LOSS OF DATA, ARISING FROM ANY CAUSE OR THEORY. AUTHORIZED RESELLERS ARE NOT AUTHORIZED TO EXTEND ANY DIFFERENT WARRANTY ON FLUKE'S BEHALF. Since some states do not allow the exclusion or limitation of an implied warranty or of incidental or consequential damages, this limitation of liability may not apply to you. If any provision of this warranty is held invalid or unenforceable by a court or other decision-maker of competent jurisdiction, such holding will not affect the validity or enforceability of any other provision.

Table of Contents

Title	Page
Multimeter Safety	1
Operating Features	4
Applications	8
Voltage, AC/DC	8
Current, AC/DC	8
Resistance and Diode Test/Continuity.....	9
Resistance Measurement	9
Diode Test and Continuity	9
Conductance	9
Leakage Testing	10
Analog Bar Graph Application	11
Using the Analog Bar Graph.....	11
Specific Applications--Nulling	12
Specific Applications--Contact Bounce.....	12

Specific Applications--Checking Capacitors.....	12
Specific Applications--Noisy Resistance Measurements.....	15
Operator Maintenance	15
Battery Installation or Replacement	16
Fuse Test	18
Fuse Replacement	18
General Maintenance.....	19
Service	21
Specifications.....	22

Multimeter Safety

Read this information before using the meter. This meter complies with EN 61010-1:1993, ANSI/ISA S82.01-1994 and CAN/CSR C22.2 No. 1010.1-92 Overvoltage Category III. Use the meter only as specified in this Users Manual, otherwise the protection provided by the meter may be impaired.

- A Warning identifies conditions and actions that pose hazard(s) to the user.
- A Caution identifies conditions and actions that may damage the meter or the equipment under test.

Warnings

To avoid possible electric shock or personal injury:

- **Inspect the meter before using it. Check for cracks, missing plastic, or other possible damage to the case. Make sure that the insulation surrounding the connectors is intact.**
- **Inspect the test leads for damaged insulation, exposed metal, and continuity. Replace damaged test leads before using the meter.**
- **Do not use the meter if it operates abnormally. Protection may be impaired. When in doubt, have the meter serviced.**
- **Do not operate the meter around explosive gas, vapor or dust.**
- **Do not apply more than the rated voltage (1000 V) between terminals or between any terminal and earth ground. The rated voltage is marked on the meter.**
- **Before each use, verify the meter's operation by measuring a known voltage.**
- **Use only specified replacement parts.**
- **Use caution when working above 30 V ac rms, 42 V ac peak, or 60 V dc. Such voltages pose a shock hazard.**
- **When using the probes, always place fingers behind the probe finger guards.**
- **Connect the common test lead before connecting the live test lead. When disconnecting test leads, disconnect the live test lead first.**
- **Make sure the battery door is closed and latched before operating the meter.**

- Remove test leads from the meter before opening the battery door.
- Use only a properly installed, single 9 V battery to power the meter.
- Follow all equipment safety procedures.
- Check the meter's fuses (see "Testing the Fuses") before measuring current.
- Never touch the probe to a voltage source when the test leads are plugged into the 10 A or 40 mA input jacks.
- The use of makeshift fuses and the short-circuiting of fuse holders is prohibited.
- To avoid false readings, which could lead to possible electric shock or personal injury, replace the battery as soon as the battery indicator () appears.

International symbols used on the meter and in this manual are explained in Table 1.

Table 1. International Electrical Symbols











	OFF (power) SWITCH POSITION		GROUND
	ON (POWER) SWITCH POSITION		SEE EXPLANATION IN MANUAL
	AC-ALTERNATING CURRENT		DOUBLE INSULATION (Protection Class II)
	DC-DIRECT CURRENT		FUSE
	EITHER DC OR AC		BATTERY

Table 2. Input Terminals and Limits

Function	Input Terminals		Min Display Reading	Max Display Reading	Maximum Input
	Red Lead	Black Lead			
\overline{V} \tilde{V}	V Ω \rightarrow \rightarrow	COM	0.001 V	1000 V	1000 V
\overline{mV} \tilde{mV}	V Ω \rightarrow \rightarrow	COM	0.1 mV	320.0 mV	1000 V
Ω (nS)	V Ω \rightarrow \rightarrow	COM	0.1 Ω	32.00 M Ω	1000 V
	V Ω \rightarrow \rightarrow	COM	0.01 nS	32.00 nS	1000 V
$\left(\left \left \left \left \right. \right. \right. \right. \rightarrow$	V Ω \rightarrow \rightarrow	$\tilde{mA/A}$	0.001 V	2.08 V	1000 V
$\overline{mA/A}$ $\tilde{mA/A}$	A	COM	0.01 A	20.00 A*	11 A 1000 V Fast Fuse**
	\tilde{mA} μA	COM	0.01 mA	320.0 mA	44/100 A 1000 V Fast Fuse**
$\overline{\mu A}$ $\tilde{\mu A}$	\tilde{mA} μA	COM	0.1 μA	3200 μA	44/100 A 1000 V Fast Fuse**

*10A continuous, 20A overload for 30 seconds maximum
**Fuse protected

Operating Features

The following features are keyed by number to the illustration inside the front cover.

① *Digital Display*

3200 count, liquid crystal display with automatic decimal point positioning. Updated two times per second. When the meter is first turned on, all display segments appear while the instrument performs a brief power-up self-test.

② *Function Selector Rotary Switch*

Turn to select any of 10 different functions, or OFF. Refer to the Specifications for available ranges and to Table 2 for input terminals and limits.

\bar{V} Volts dc

\bar{mV} Millivolts dc

\tilde{V} Volts ac

\tilde{mV} Millivolts ac

Ω Ohms (resistance), also conductance ($1/\Omega$) in nanosiemens (nS)

$\left(\left| \left| \left| \left| \right. \right. \right. \right. \rightarrow +$ Continuity or diode test

$\bar{mA/A}$ Milliamps or amperes dc

$\bar{\mu A}$ Microamps dc

$\tilde{mA/A}$ Milliamps or amperes ac

$\tilde{\mu A}$ Microamps ac

③ $V\Omega \rightarrow +$ *Volt, Ohms, Diode Test Input Terminal*

Input terminal used in conjunction with the volts, mV (ac or dc), ohms, or diode test position of the function selector rotary switch.

④ **COM** *Common Terminal*

Common or return terminal used for all measurements.

⑤ $\frac{mA}{\mu A}$ *Milliamp/Microamp Input Terminal*

Input terminal used for current measurements up to 320 mA (ac or dc) with the function selector rotary switch in the mA or μA positions.

⑥ **A** *Amperes Input Terminal*

Input terminal used for current measurements up to 10A continuous (20 A overload for 30 seconds) with the

function selector rotary switch in the mA/A position (ac or dc).

⑦ RANGE ◻ *Manual Range Mode Pushbutton*

Press once to enter manual range mode, press again to increment range, press and hold for 2 seconds to return to autorange. Meter returns to autorange if the function selector is switched to any other position. There is no autorange annunciator; absence of the manual range annunciator indicates the meter is in autorange. If RANGE is depressed (>1 second) while the function switch is moved from OFF to any ON position, manual ranging will be selected in all functions.

⑧ REL △ *Relative Mode Pushbutton*

Press momentarily to enter the Relative mode and store the displayed reading. The display will read zero. Press again to update the stored digital reading. Press and hold for 2 seconds to exit the Relative mode. The Relative mode stores a digital reading and displays the change (difference) between the stored reading and any following reading. For example, if the stored reading is 15.00 V and the present readings is 14.10 V, the display will indicate - 0.90V. The analog bar graph continues to display the actual reading (14.10V). If the difference exceeds 3999

counts (without overloading the input), OF (overflow) is displayed. The Relative mode selects manual ranging; changing ranges automatically exits the Relative mode.

⑨ MIN/MAX Mode Pushbutton

Press momentarily to enter MIN/MAX mode, press again to toggle between MIN and MAX indications. Press and hold for 2 seconds to exit MIN/MAX mode. The meter stores the minimum and maximum digital readings, and will display either reading as selected by the operator. Press the HOLD/RESET button to reset the MIN/MAX readings to the present input. The MIN/MAX mode selects manual ranging; use a range that can record the maximum anticipated input. Range changes reset previously recorded MIN/MAX readings. Exiting the MIN/MAX mode does not reset the previously recorded readings unless the range or function is changed. The MIN/MAX mode overrides the Touch Hold® mode.

⚠ Warning

To avoid electric shock or personal injury, do not use Touch Hold® to determine that circuits with dangerous voltages are de-energized. Touch Hold® will not capture unstable or noisy readings.

⑩ HOLD  *Touch Hold[®] Mode Pushbutton*

Press momentarily to enter Touch Hold[®] mode. In Touch Hold[®], the meter captures a stable measurement and holds it in the display. The operator can watch the probes while taking measurements in difficult or hazardous circuits, then look at the display when convenient. The meter beeps and the display is automatically updated each time a new, stable measurement is made. Press momentarily to manually update reading. Press and hold for 2 seconds to exit Touch Hold[®] mode. If HOLD is depressed (>1 second) while the function switch is moved from OFF to any ON position, the Touch Hold[®] mode will only update to a new reading when the HOLD button is pressed and automatic Touch Hold[®] updates are defeated. This is useful when you want to take a reading at a specific time and hold it.

⑪ MIN *Minimum Annunciator*

Indicates that the meter is in the MIN/MAX recording mode, and the value displayed is the minimum digital reading taken since reset or since entering MIN/MAX. Refer to item 9 for operation.

⑫ MAX *Maximum Annunciator*

Indicates that the meter is in the MIN/MAX recording mode, and the value displayed is the maximum digital reading taken since reset or since entering MIN/MAX. Refer to item 9 for operation.

⑬  *Relative Annunciator*

Indicates that the meter is in the Relative mode and that the value displayed is relative (the difference between the present measurement and the previously stored reading). Refer to item 8 for operation.

⑭  *Touch Hold[®] Mode Annunciator*

Displayed when the Touch Hold[®] mode is in use. Refer to item 10 for operation.

⑮ MkΩ *Resistance Annunciators*

The appropriate annunciator (Ω , k, or M) is displayed for the resistance range in use.

⑯ nS *Conductance Range Annunciator (nS)*

Top range of the resistance function is the conductance range. Displays conductance in nS (nanosiemens). 1000

nS converts to megohms. (Example: 2 nS converts to 500 M Ω .) Use for measuring resistance above 32 megohms. Select Ω , open test leads, press RANGE button twice. Refer to item 7 for manual range operation.

⑰ *Analog Bar Graph Display*

Analog representation of input. Composed of 31 segments which illuminate starting from the left as the input increases. (See display inside rear cover.) A minus sign (-) is displayed for reverse-polarity inputs. Updated 25 times per second.

⑱ *Decimal Point/Range Indicator*

Decimal point position and the digits (3, 30, 300) under the decimal point indicate the range in use.

⑲ *Manual Range Annunciator*

Displayed in the Manual Range mode or if the selected function has only one range. Absence of the indicator implies autorange mode in use. The meter powers-up in autorange. In autorange, the meter automatically selects the measurement range. Refer to item 7 for operation.

⑳ *Low Battery Annunciator*

Battery voltage is tested each time the function switch is moved to a new position.

Warning

To avoid false readings, which could lead to possible electric shock or personal injury, replace the battery as soon as the low battery indicator () appears.

㉑ *Negative Polarity Annunciator*

Automatically indicates negative input.

㉒ *Overload Indication*

These symbols indicate the input is too large for the input circuitry. (The location of the decimal point depends on the measurement range.)

㉓ *Overflow Indication*

These symbols indicate the calculated difference in the Relative mode is too large to display (>3999 counts) and that the input is not overloaded.

②4 *Beeper (not illustrated)*

The beeper can produce beeps, clicks, or a continuous tone. It is used for audible indication in the diode test mode, when operating the push buttons, and when a new reading is displayed in the Touch Hold[®] mode.

Tilt Bail Adjustment

To use the tilt bail as a handle, lift the bail slightly (about 1 inch or 2.5 cm), pull the ends out and insert the ends in the alternate set of holes.

Applications

Voltage, AC/DC

All ranges present an input impedance of approximately 10 megohms in parallel with less than 100 pF.

Measurement errors, due to circuit loading, can result when making either ac or dc voltage measurements on circuits with high source resistance. However, in most cases the error is negligible (0.1% or less) if the measurement circuit source resistance is 10 kilohms or less.

When measuring voltages above 320 V in Touch Hold[®] mode, use manual ranging to minimize readings of stray voltages.

Current, AC/DC

⚠ Warning

To avoid electric shock or personal injury:

- **Never attempt an in-circuit current measurement where the open-circuited potential to earth is greater than 1000 V.**
- **Before measuring current, check the meter's fuses (see "Testing the Fuses").**
- **Turn off circuit power before connecting the meter in the circuit. Remember to place the meter in series with the current. Use proper terminals, function, and range for your measurement.**

To prevent arc blast and resulting injury, install only the EXACT replacement fuse listed in the Maintenance section.

All current ranges are fuse protected. Approximate terminal resistances for the current ranges are: 0.1 ohms for A, 5.6 ohms for mA, and 500 ohms for μ A. The voltage developed across the terminal resistance is specified as burden voltage. If a fuse opens, refer to the fuse replacement procedures in the Operator Maintenance section of this manual.

Resistance and Diode Test/Continuity

Caution

To avoid possible damage to the meter or to the equipment under test, disconnect circuit power and discharge all high voltage capacitors before measuring resistance, testing for continuity, or diode test.

Resistance Measurement

Test lead resistance may influence measurement accuracy on the 320-ohm range. To determine the error, short the test leads together and read the lead resistance. Correct the measurement by subtracting the lead resistance from the measurement, or use the Relative (REL) mode to zero the display. The error is usually 0.1 to 0.2 ohms for a standard pair of test leads.

Some in-circuit resistance measurements can be made without removing diodes and transistors from the circuit. The full-scale measurement voltage produced on ranges below 32 megohms does not strongly forward bias silicon diodes or transistor junctions. Use the highest range you can (except 32 megohm) to minimize the possibility of turning on diodes or transistor junctions. Full scale measurement voltage in the 32-megohm range does strongly forward bias a diode or transistor.

Diode Test and Continuity

In diode test, there is only one range: 0 to +2.08 volts. Voltage is developed across the component(s) under test by a test current output from the Fluke 27. Voltages greater than 2.08 V or open test leads produce an overload (OL) condition. Negative inputs produce a negative indication (they are not suppressed). In the diode test function (|<<< →| the beeper produces a continuous tone if the input is less than 0.1 V, and the beeper beeps once when the input descends through a 0.7 V threshold.

Audible continuity testing is also performed with the function selector switch in the diode test/continuity position. A continuous tone sounds for test resistances below approximately 270 ohms. An intermittent connection produces erratic beeps, and can be valuable troubleshooting aid. Erratic beeps can also occur, due to environmental noise, if a test value is very close to the threshold (270 ohms). Test resistances from approximately 270 ohms to 2600 ohms produce a short tone similar to a forward biased diode. Test resistances less than approximately 36 kilohms will produce an on-scale reading.

Conductance

Conductance measurement is performed with the function selector switch in the ohms (Ω) function. The conductance range can only be entered using manual range selection; autorange cannot enter the conductance range. The conductance range can be used both to measure conductance ($1/\Omega$, the inverse of resistance) and to measure very high resistances (greater than 32 megohms).

High value resistance measurements are susceptible to induced noise, and may require careful shielding. Conductance measurements are displayed in nanosiemens (nS). Calculate megohms by dividing 1000 by the nanosiemens displayed (1000/nS is equivalent to megohms). Example: 2 nS converts to 500 megohms (1000/2).

Leakage Testing

The conductance range effectively extends the resistance measurement capability of the Fluke 27 to the point where it can provide useful leakage measurements on passive components. For example, the operator can detect leaky diodes, cables, connectors, printed circuit boards, etc. In all cases, the test voltage is less than 2 V dc.

Leakage testing on purely resistive components such as cables and printed circuit boards is straightforward. Select the ohms function and manually increment the range to conductance (nS). Connect the test leads to the test points (nS). Connect the test leads to the test points on the unit under test, and read the leakage in terms of conductance.

Note

There is normally a small residual reading with open test leads in the conductance range. To ensure accurate measurements, connect clean test leads to the Fluke 27, and (with the leads open) read the residual leakage in nanosiemens. Correct subsequent measurements by subtracting the residual from the readings. This can be done automatically using the Relative mode (REL).

Diode leakage tests require that the diode junction be reverse biased when being measured. This is accomplished by connecting the anode of the diode to the COMMON input terminal and the cathode (ring) of the diode to the volts/ohms/diode test terminal. Leakage at the test voltage being applied can then be read in terms of conductance.

High-voltage stacked diode assemblies can usually be tested for forward and reverse resistance changes using conductance. These assemblies typically have such high forward voltage drops that the diode test or resistance modes cannot test them.

Analog Bar Graph Application

In looking at the analog bar graph, notice that it is composed of segments that simulate an analog needle. The bar graph performs the same function as an analog meter needle, but it eliminates the mechanical overshoot inherent in needle movements.

A negative (-) annunciator is displayed at the left end of the bar graph when taking a reverse polarity dc measurement. Assume that a slowly varying dc voltage is the input signal. As the input goes more positive (from zero), a bar graph segment is displayed, and additional segments are displayed from left to right, to indicate the input level as it increases. Now, assume that the input level slowly decreases. Fewer bar graph segments are displayed as the signal decreases, then the - annunciator flashes as the signal level passes through 0. As the signal goes more negative, the - annunciator is displayed from left to right, indicating a more negative input signal. The first segment is an indication greater than or equal to 20 counts.

Note that every fifth segment of the bar graph is slightly larger than those in between, and every tenth segment is larger yet. These larger segments provide a quick reference for bar graph indications. The largest segments (every 10th segment) divide the display into thirds. Thus, if the bar graph indicates 11 segments on the 32.00V range, the input voltage is 10 to 11 volts; if the bar graph indicates 11 segments on the 320.0V range, the input voltage is 100 to 110 volts. If the input equals or exceeds 3000 counts on the range selected, the bar graph displays, an arrow at the far right of the display. If the manual range annunciator (⊙) is not displayed, the Fluke 27 automatically switches to the next high range if the input exceeds approximately 3260 counts

Using the Analog Bar Graph

The analog bar graph is most useful in making adjustments and performing limited diagnostics. Bar graph response is fast and precise, so it can be used to easily reach a setting within a few percent of the final adjustment. The bar graph can be used to make rough adjustments quickly; then the 3200-count digital display can be used for final adjustment.

The analog bar graph is useful for performing limited diagnostics in applications where rapidly fluctuating signal levels cause the flashing digits of a digital display to be useless. Like the traditional VOM needle, the analog bar

graph excels at displaying trends, or slowly changing signals. In addition, autoranging on the Fluke 27 allows monitoring the signal change through changing ranges.

Many diagnostic routines using the bar graph require practice. The operator is looking for good or bad signal patterns that occur over some span of time. Capacitance checks and noisy resistance measurements create such patterns. Therefore, familiarity with analog bar graph response and movement is necessary to accurately interpret a signal pattern. Compare the bar graph response when making measurements on a known-good unit to the bar graph response when making measurements on a faulty unit.

Specific Applications--Nulling

The Fluke 27 bar graph is ideal for nulling adjustments. As an adjustment approaches zero, fewer bar graph segments are displayed, then no bar graph segments are displayed. The - annunciator flickers when the input level is within 10 counts to zero. The flickering null indication is displayed every time the input approaches zero or swings from one polarity to the other. The operator merely watches for the - annunciator indication, then reverses the direction of the adjustment when the polarity sign is displayed. In one or two passes, a near-zero input level is possible, then the digital display can be used for exact zero adjustment.

Specific Applications--Contact Bounce

When subject to vibration, relay contacts may begin to bounce open. Checking for this intermittent problem is a routine troubleshooting measure associated with many types of equipment, including computers. Since the bounce problem will worsen as the relay fatigues, early diagnosis is important.

When the contact bounces open, its resistance value changes momentarily from zero to infinity and back. Ordinary hand-held DMMs take more than 300 milliseconds to update their displays--much too long to detect a brief contact bounce. A traditional VOM needle will move slightly at the instant of contact bounce, but the inertia of the needle movement dampens the response.

The analog bar graph, however, will display at least one segment the moment the contact opens. The bar graph can detect contact bounce as brief as 0.2 milliseconds, while most analog needle movements require a 3 millisecond opening before they will respond.

Specific Applications--Checking Capacitors

Volt-ohm meters are often used as simple capacitor checkers. In the capacitor kick test, the needle of the VOM in the resistance mode moves quickly from open (infinite ohms) toward short (zero ohms) as the capacitor is placed across the VOM input. The VOM battery

charges the capacitor and the needle slowly moves back to the open (infinite ohms) position. The higher resistance ranges offer increased sensitivity for checking smaller capacitors.

The analog bar graph can make similar checks in the resistance function, even in the autoranging mode. As a capacitor is placed across the inputs, the analog bar graph quickly shortens, then rapidly down-ranges, depending on the size of the capacitor. As the capacitor charges, the bar graph slowly extends back to its full 31-segment length, up-ranging if necessary. For capacitors as small as 0.1 μ F, only the 32-megohm range is involved.

In a fixed range (using manual range mode), the time it takes for the bar graph to extend from zero to full scale indicates the approximate capacitance value. Table 3 gives typical capacitance values for various charge times on different resistance ranges. For very small capacitors, use the conductance (nS) mode.

Table 3. Capacitance Vs. Time to Full Scale

Capacitance Value	Resistance Range					
	320 Ω	3.2 k Ω	32 k Ω	320 k Ω	3.2 M Ω	32 M Ω
10,000 μF	4 sec	33 sec	5 min	ext	ext	ext
1,000 μF	nil	4 sec	30 sec	ext	ext	ext
100 μF	nil	nil	3 sec	28 sec	ext	ext
10 μF	nil	nil	nil	3 sec	25 sec	ext
1 μF	nil	nil	nil	nil	2 sec	15 sec
0.1 μF	nil	nil	nil	nil	nil	2 sec

ext = extended time, nil = no indication

Specific Applications--Noisy Resistance Measurements

Most digital multimeters are so sensitive they can not tolerate as much as 50 mV of the line noise while making resistance measurement; their digital displays become unreadable due to the line noise. On the other hand, because of the mechanical inertia of the analog needle, the noise alternately pulls the needle to the left and then to the right, averaging out any movement and leaving a fairly stable resistance reading.

The Fluke 27 resistance measurement circuit is designed to tolerate ac noise far better than the usual DMM. Readable 2-kilohm readings can be obtained even in the presence of 1 V ac noise. Readings of 1 megohm may be obtained with up to 2 V ac noise. The noise appears as about 50 counts of change and an oscillating bar graph.

Operator Maintenance

⚠ Warnings

To avoid possible electric shock or personal injury:

- **Do not allow water to get inside the case.**
- **Remove any input signals prior to removing test leads and opening case.**
- **When servicing the meter, use only specified replacement parts.**
- **Before closing battery door, make sure fuse cover is in place.**
- **Make sure the battery door is closed and latched before you operate the meter.**

To prevent arc blast and resulting injury, install only the EXACT replacement fuse listed in the Maintenance section.

Battery Installation or Replacement

A single 9V battery (NEDA 1604, 6F22, or 006P) supplies power to operate the Fluke 27. Referring to Figure 1, use the following procedure to replace the Fluke 27 battery:

1. Turn the rotary switch to OFF, and remove the test leads.
2. Lift the instrument stand on the back of the Fluke 27, then remove the four black, #6 X 32, Pozi-drive® screws from the battery cover.
3. Pull the battery cover straight out from the back of the meter. (A coin-slot in the side of the battery cover facilitates removal.)
4. Remove and disconnect the battery.
5. Snap the battery connector to the terminals on the new battery, then slide the battery into the battery compartment.
6. Insert the battery spacer/cover into the Fluke 27, then start the four screws removed in step 2. Press firmly on the battery cover while tightening the screws in a diagonal pattern.

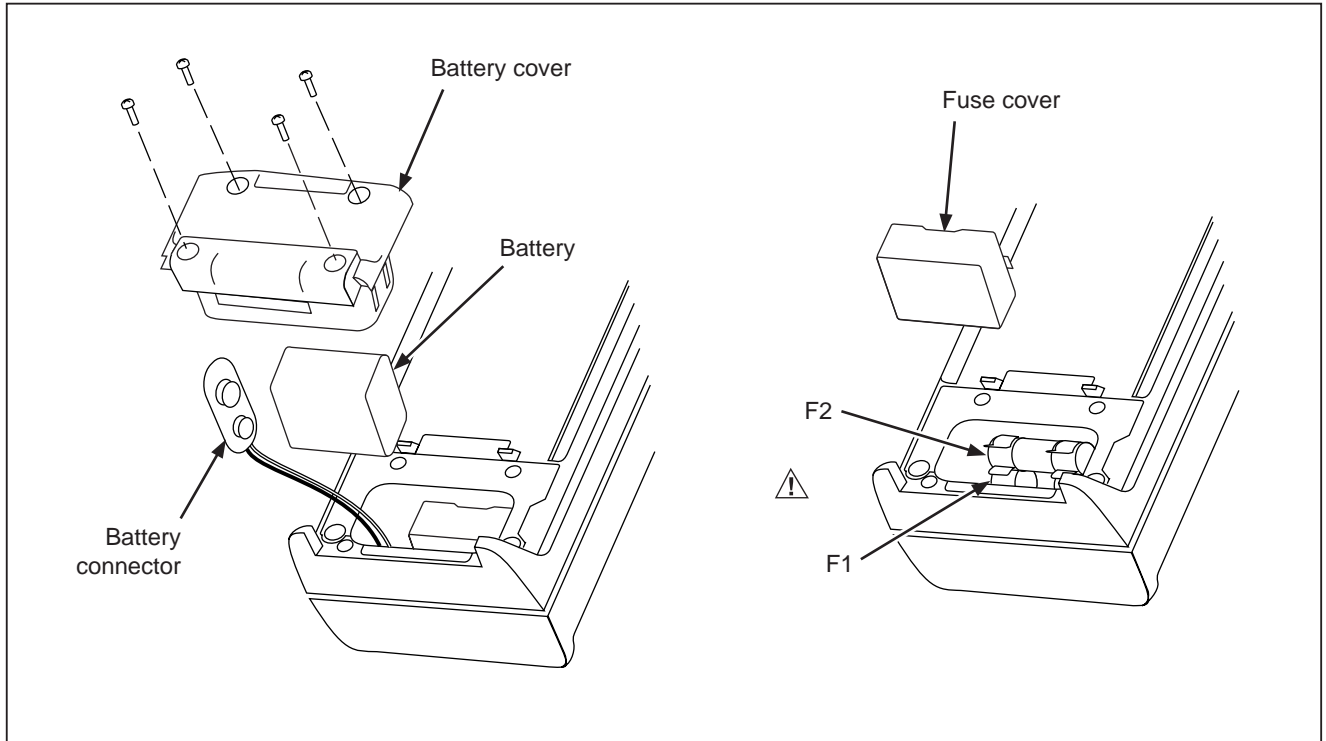

Figure 1. Battery and Fuse Replacement

ye1f.eps

Fuse Test

Warnings

To avoid possible electric shock or personal injury:

- Remove the test leads and any input signals before replacing battery or fuses.
- Before closing battery door, make sure fuse cover is in place.
- Make sure the battery door is closed and latched before you operate the meter.

To prevent arc blast and resulting injury, install only the EXACT replacement fuse listed in Table 4.

1. Turn the function selector switch to the Ω position.
2. Connect a test lead from the **V Ω \rightarrow** input terminal to the A input terminal.
3. The display should indicate between 0.1 ohm and 0.3 ohm. This tests F2 (11A, 1000V fast).
4. Move one end of the test lead from the A input terminal to the mA/ μ A input terminal.

5. The display should indicate between 5.3 ohms and 6.0 ohms. This tests F1 (44/100A, 1000V fast).
6. If either of the above display indications is OL (overload), replace the appropriate fuse.

Fuse Replacement

Warning

To avoid personal injury, do not use makeshift fuses or short-circuit the fuse holders.

Referring to Figure 1, use the following procedure to check or replace the Fluke 27 fuses:

1. Perform steps 1 through 4 of the battery replacement procedure.
2. Pull the fuse cover down, then out of the meter.
3. Remove the defective fuse (or check continuity through the suspected fuse), and if necessary install a new fuse of the same size and rating.
4. Snap the fuse cover back into place.
5. Reinstall the battery spacer/cover as instructed in step 6 of the battery replacement procedure.

Table 4. Replacement Fuses

Item	Description	PN	Qty
F1 ⚠	Fuse, F44/100A, 1000 VAC/DC	943121	1
F2 ⚠	Fuse, F11A, 1000 VAC/DC	803293	1
⚠ To ensure safety, use exact replacement only			

General Maintenance

Clean the case with a damp cloth and detergent; do not use abrasives or solvents.

The Fluke 27 is sealed to protect the instrument. To maintain proper sealing, open only the battery/fuse compartment.

Have the meter calibrated and the seals (part number 738112) replaced by a qualified technician once a year to ensure specified performance. Contact the nearest Fluke Service Center or refer to the Fluke 27 Service Manual (part number 690206) for calibration or repair. Refer to Table 5 for replaceable parts.

Table 5. Replaceable Parts

Item	Description	PN	Qty
BT1	Battery, 9V	696534	1
H6	Screw, PH 6-32 x 3/8	682070	4
MP11	Foot, Case	654335	1
MP12	Bail, Tilt (Bracket)	744474	1
MP14	Cover, Battery	670585	1
MP15	O-Ring, Battery	697185	1
MP16	Spacer, Battery	665023	1
MP61	Fuse Cover	665031	
TL75*	Test Lead Set		1
AC70*	Alligator Clip Set		1
TM1	Users Manual	690203	1
TM2	Service Manual	690206	1
*Accessory Number			

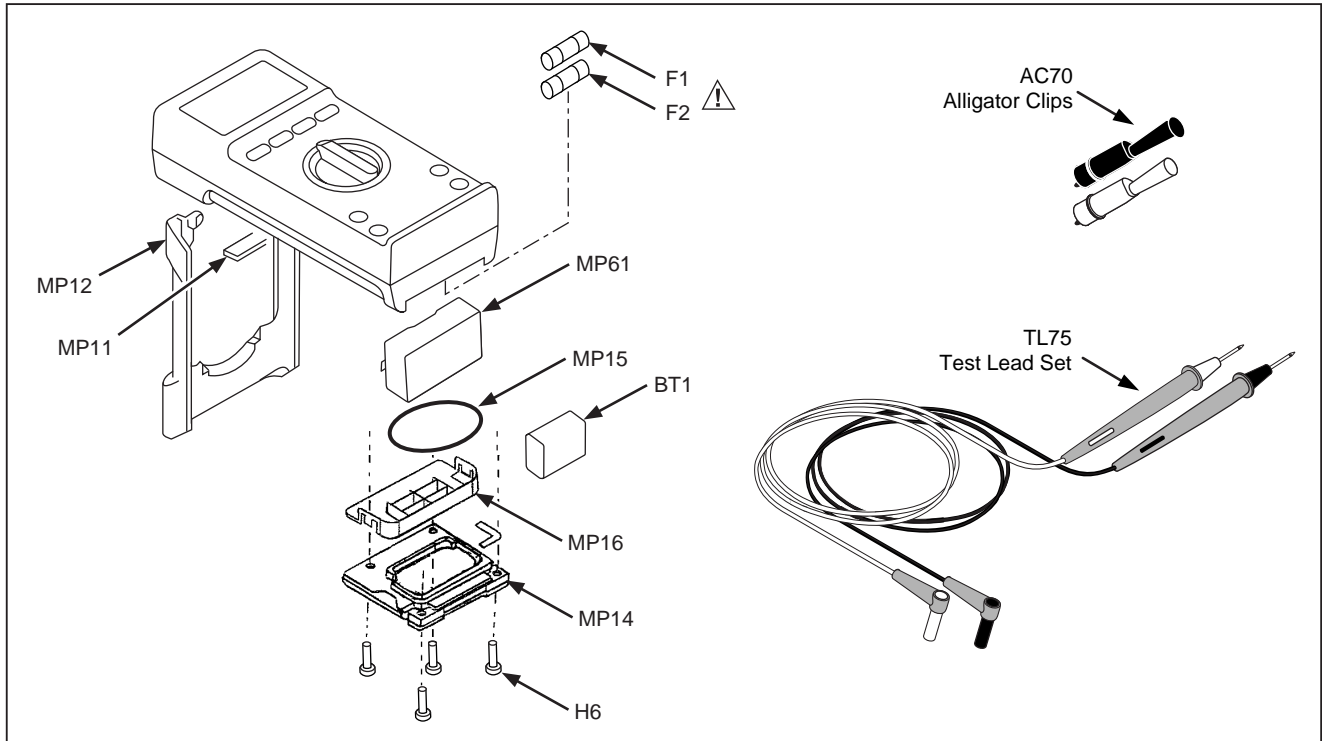

ye2c.eps

Figure 2. Replaceable Parts

Service

To contact Fluke, call one of the following telephone numbers:

USA: 1-888-99-FLUKE (1-888-993-5853)

Canada: 1-800-36-FLUKE (1-800-363-5853)

Europe: +31 402-678-200

Japan: +81-3-3434-0181

Singapore: +65-738-5655

Anywhere in the world: +1-425-356-5500

Or, visit Fluke's Web site at www.fluke.com.

Specifications

Function	Range	Resolution	Accuracy*		
\bar{V}	3.200 V	0.001 V	$\pm(0.1\%+1)$		
	32.00 V	0.01 V	$\pm(0.1\%+1)$		
	320.0 V	0.1 V	$\pm(0.1\%+1)$		
	1000 V	1 V	$\pm(0.1\%+1)$		
\bar{mV}	320.0 mV	0.1 mV	$\pm(0.1\%+1)$		
Ω (nS)	320.0 Ω	0.1 Ω	$\pm(0.3\%+3)**$		
	3.200 k Ω	0.001 k Ω	$\pm(0.2\% +1)$		
	32.00 k Ω	0.01 k Ω	$\pm(0.2\% +1)$		
	320.0 k Ω	0.1 k Ω	$\pm(0.2\% +1)$		
	3.200 M Ω	0.001 M Ω	$\pm(0.2\% +1)$		
	32.00 M Ω	0.01 M Ω	$\pm(1\%+1)$		
	32.00 nS	0.01 nS	$\pm(2\%+10)$		
$\left(\left(\left(\left(\left(\rightarrow\right)\right)\right)\right)\right)$	2.080 V	0.001 V	$\pm(1\%+1)$ typical		
\tilde{V}	3.200 V 32.00 V 320.0 V 1000 V	0.001 V 0.01 V 0.1 V 1 V	40 Hz-2 kHz	2 kHz-10 kHz	10 kHz-30 kHz
			$\pm(0.5\%+3)$	$\pm(2\%+3)$	$\pm(4\%+10)$
			$\pm(0.5\%+3)$	$\pm(2\%+3)$	$\pm(4\%+10)$
			$\pm(0.5\%+3)$	$\pm(2\%+3)$	$\pm(4\%+10)$
			$\pm(1\%+3)$	$\pm(3\%+3)$	Not Specified
\tilde{mV}	320.0 mV	0.1 mV	$\pm(0.5\%+3)$	$\pm(2\%+3)$	$\pm(4\%+10)$

** When using the REL (Δ) function to compensate for offsets

Function	Range	Resolution	Accuracy	Typical Burden Voltage
$\overline{\text{mA/A}}$	32.00 mA	0.01 mA	$\pm(0.75\%+2)$	5.6 mV/mA
	320.0 mA	0.1 mA	$\pm(0.75\%+2)$	5.6 mV/mA
	10.00 A	0.01 A	$\pm(0.75\%+2)$	50 mV/A
$\overline{\mu\text{A}}$	320.0 μA	0.1 μA	$\pm(0.75\%+2)$	0.5 mV/ μA
	3200 μA	1 μA	$\pm(0.75\%+2)$	0.5 mV/ μA
$\widetilde{\text{mA/A}}$ 40-1000 Hz	32.00 mA	0.01 mA	$\pm(1.5\%+2)$	5.6 mV/mA
	320.0 mA	0.1 mA	$\pm(1.5\%+2)$	5.6 mV/mA
	10.00 A	0.01 A	$\pm(1.5\%+2)$	50 mV/A
$\widetilde{\mu\text{A}}$ 40-1000 Hz	320.0 μA	0.1 μA	$\pm(1.5\%+2)$	0.5 mV/ μA
	3200 μA	1 μA	$\pm(1.5\%+2)$	0.5 mV/ μA

* Accuracy is specified as \pm ([% of reading] + [number of least significant digits]).

Basic electrical accuracy is specified from 18°C to 28°C with relative humidity up to 95%, for a period of one year after calibration. All ac conversions are ac coupled, average responding, and calibrated to read the true rms value of a sine wave input.

Ranging is either automatic or manual in all functions with more than one range. Test resistance below approximately 270 Ω in the Diode test function produces a continuous audible tone.

Function	Overload Protection*	Input Impedance (Nominal)	Common Mode Rejection Ratio (1 k Ω unbalance)	Normal Mode Rejection
$\overline{\overline{V}}$	1000 V rms	10 M Ω in // with <100 pF	>120 dB at dc, 50 Hz, or 60 Hz	>60 dB at 50 Hz or 60 Hz
\overline{mV}	1000 V rms	10 M Ω in // with <100 pF	>120 dB at dc, 50 Hz, or 60 Hz	>60 dB at 50 Hz or 60 Hz
\tilde{V}	1000 V rms	10 M Ω in // with <100 pF (ac coupled)	>60 dB, dc to 60 Hz	
\tilde{mV}	1000 V rms	10 M Ω in // with <100 pF (ac coupled)	>60 dB, dc to 60 Hz	
Ω	1000 V rms	Open Circuit Test Voltage	Full Scale Voltage	
		<2.8 V dc	Up to 3.2 M Ω	32 M Ω or nS
			<420 mV dc	<1.3 V dc
*10 ⁷ V Hz Max				

Maximum Voltage Between Any Terminal and Earth Ground
1000 V

Function	Fuse Protection
mA or μ A A	44/100 A 1000 V Fast 11 A 1000 V Fast

Digital Display	3200 counts, updates 2/sec
Analog Display	31 Segments, updates 25/sec
Operating Temperature	-15°C to 55°C, to -40°C for 20 minutes when taken from 20°C
Storage Temperature	
Without Battery	-55°C to 85°C
With Battery	-55°C to 60°C
Electromagnetic Compatibility	In an RF field of 3 V/m on all ranges and functions except mVAC, total accuracy = specified accuracy +1.0% of range. For mVAC, total accuracy = specified accuracy + 1.5% of range. EN 61326-1:1997
Temperature Coefficient	0.1X (specified accuracy)/ °C (<18°C or >28°C)
Relative Humidity	0% to 95% (0°C to 35°C) 0% to 70% (35°C to 55°C)
Battery Type	9 V, NEDA 1604 or 6F22 or 006P
Battery Life	1000 hrs. typical
Shock, Vibration and Water Resistance	Per MIL-T-28800 for a Style A, Class 2 Instrument
Size (H X W X L)	2.2 in X 3.75 in X 8 in (5.6 cm X 9.5 cm X 20.3 cm)
Weight	1.6 pounds (0.75 kg)
Altitude	2000 m maximum
Safety	Complies with ANSI/ISA S82.01-1994, CAN/CSA C22.2 No. 1010.1:1992, 1000 V Overvoltage Category III. UL license pending to UL3111-1.

Test Equipment Depot
99 Washington Street
Melrose, MA 02176-6024

www.testequipmentdepot.com
800-517-8431
781-665-0780 FAX